

Aşağıdaki sınıfta kullandığımız malzemeleri kesik çizgilerin üzerinden giderek birleştirir misin ?

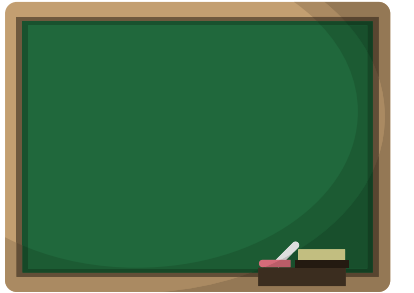

Aşağıdaki sınıfta kullandığımız malzemeleri kesik çizgilerin üzerinden giderek birleştirir misin ?

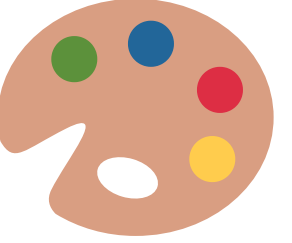
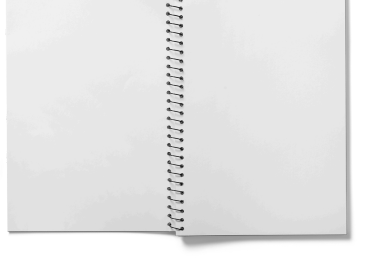
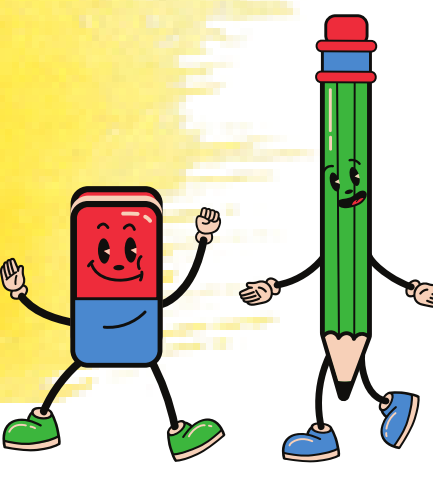
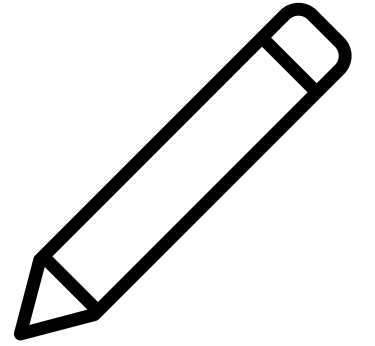
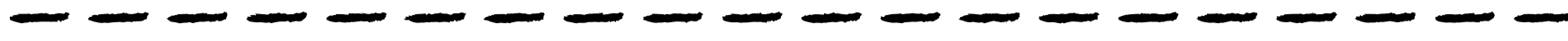
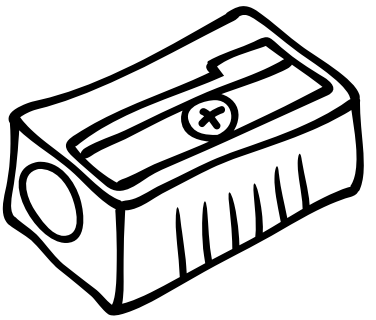
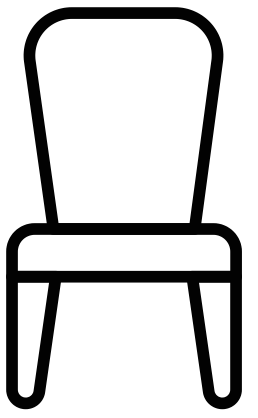
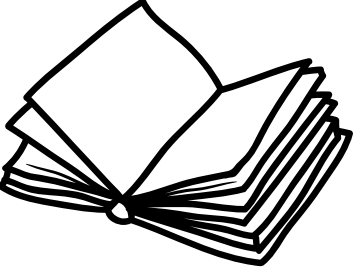
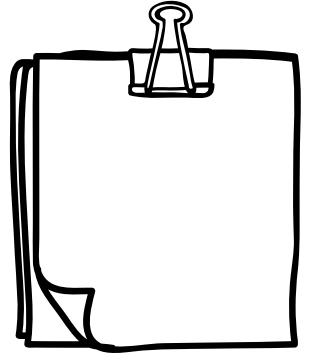
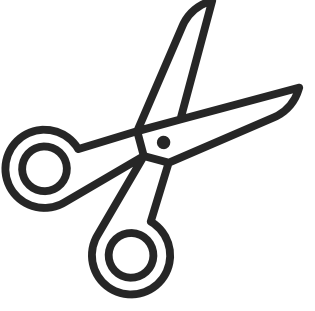
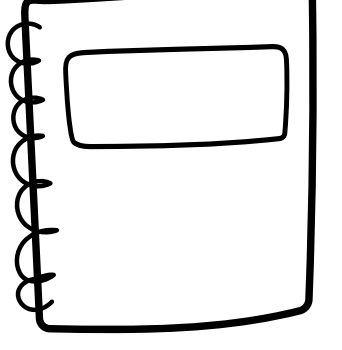
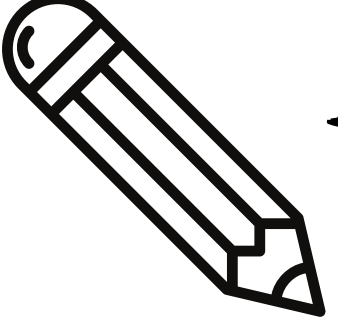
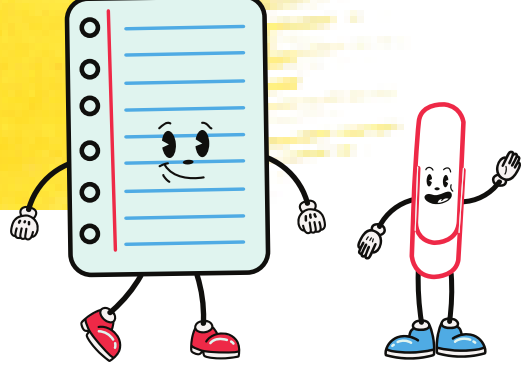

Aşağıdaki sınıfta kullandığımız malzemeleri gölgeleri ile eşleştirir misin?

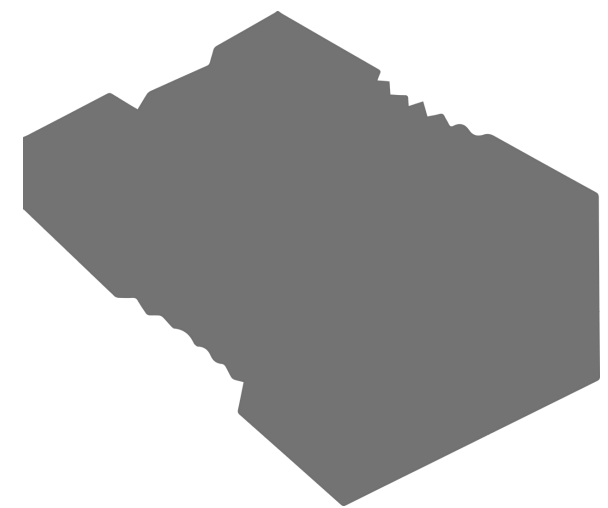
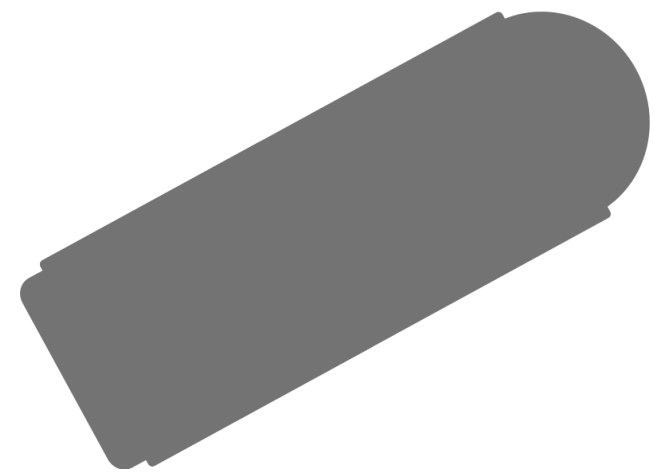
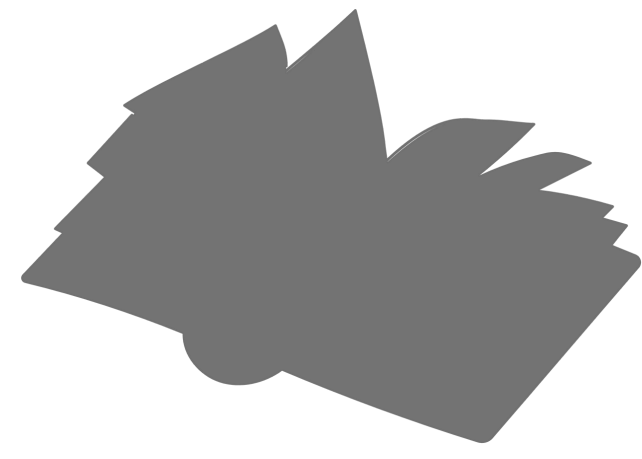
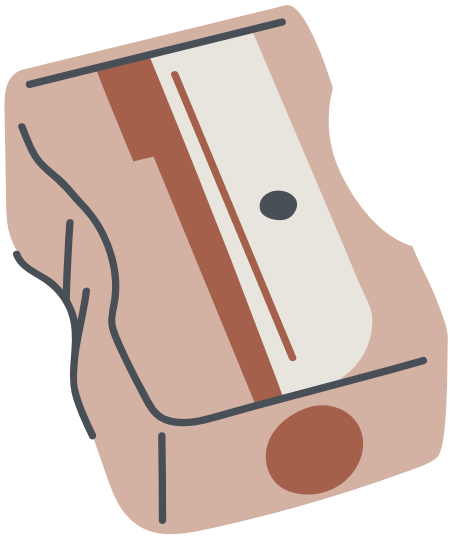
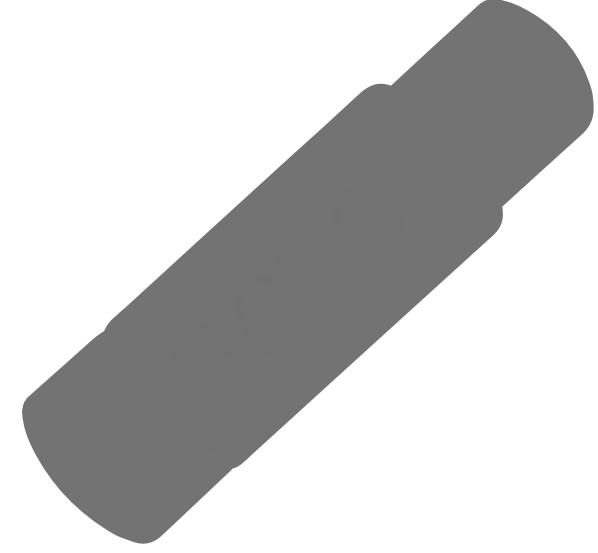
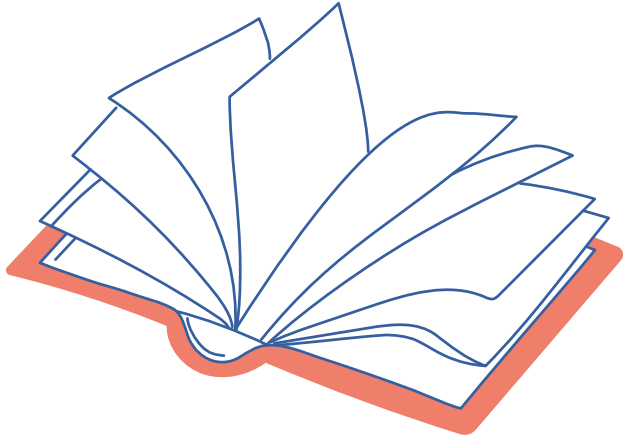

Aşağıdaki sınıfta kullandığımız malzemeleri gölgeleri ile eşleştirir misin?

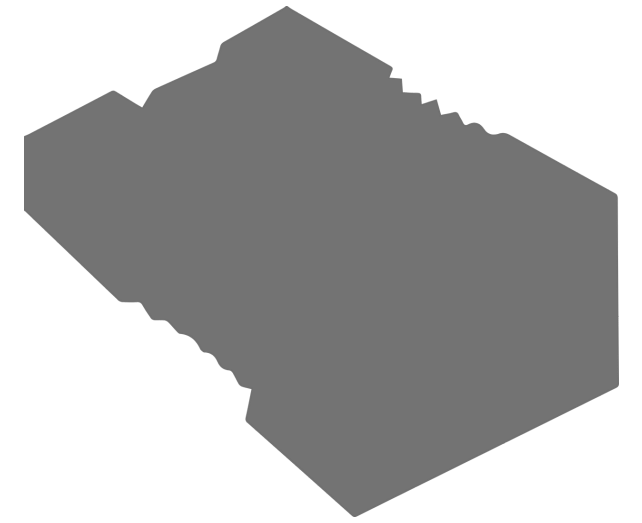
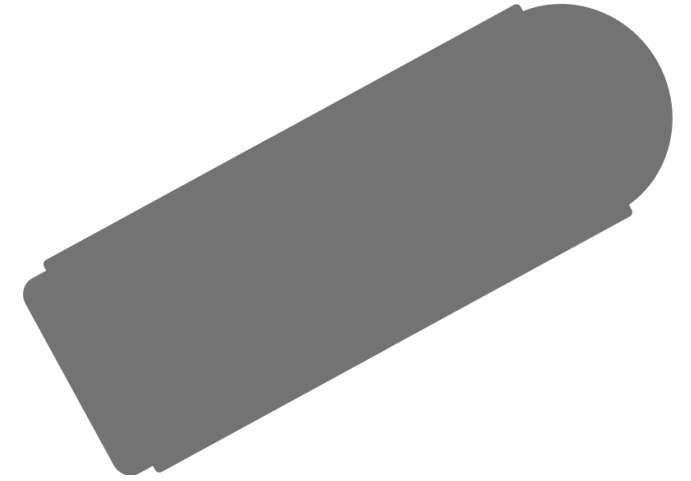
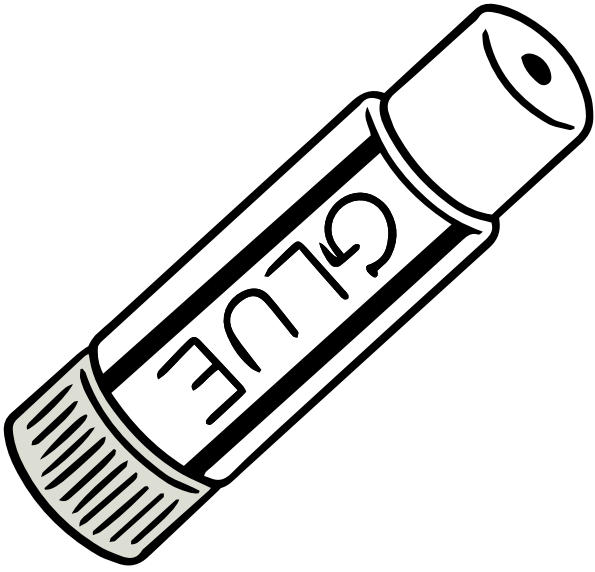
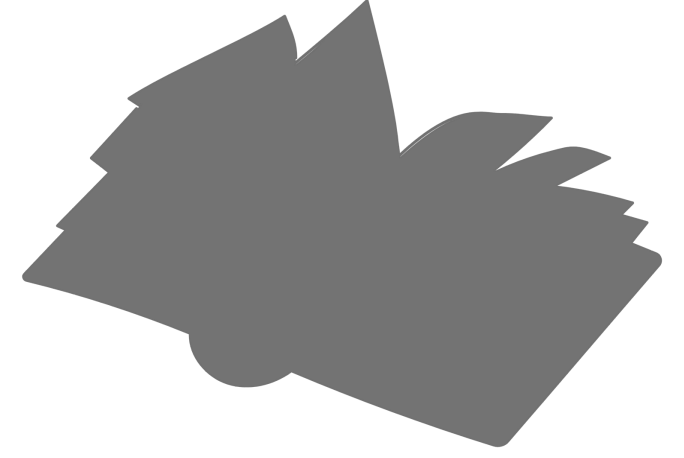
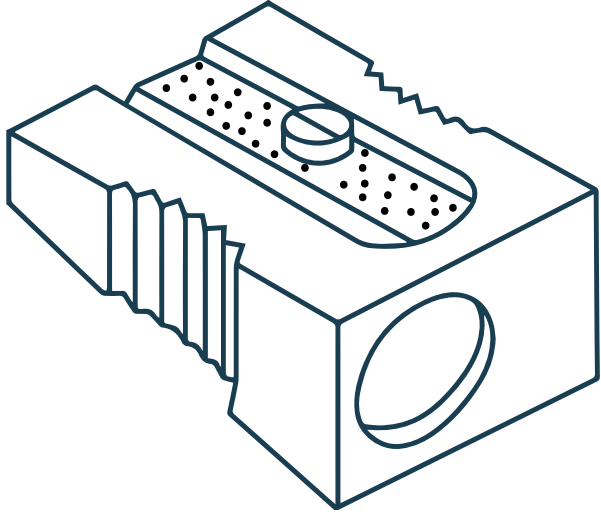
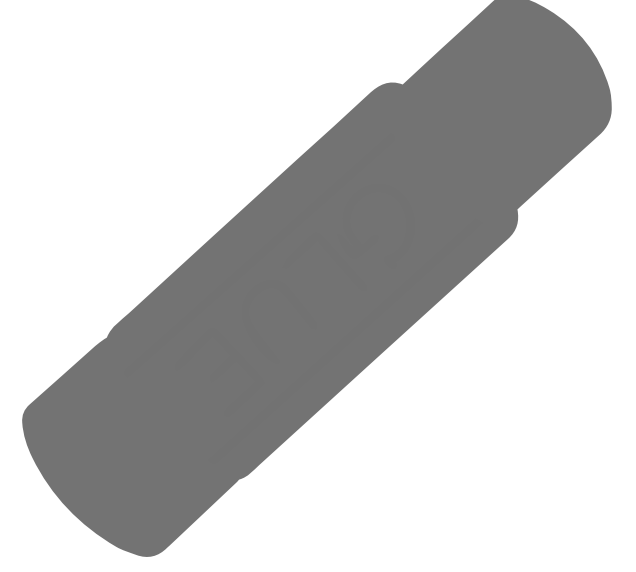
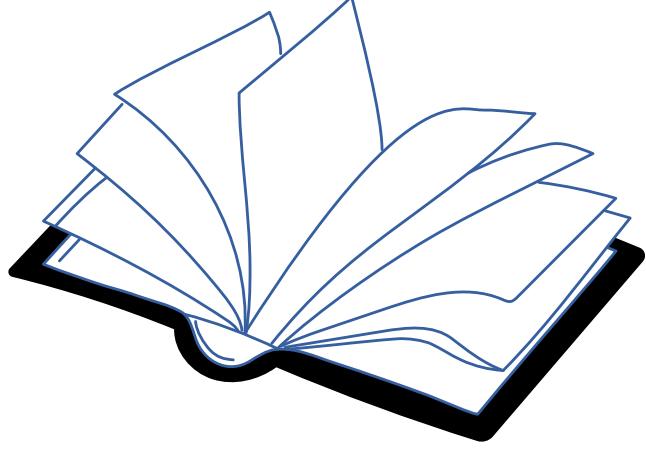

Kalemiço arkadaşı kalemtraşa ziyarete gidecek. Ona yolu gösterir misin ?

