

DENEY GÖZLEM FORMU

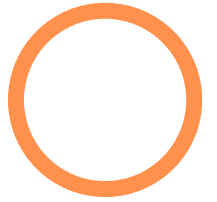

Yönerge: Miktatsın çektiklerini işaretler misin?

DENEY GÖZLEM FORMU

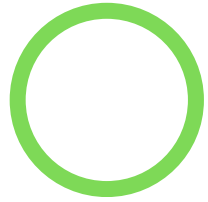
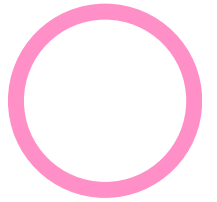
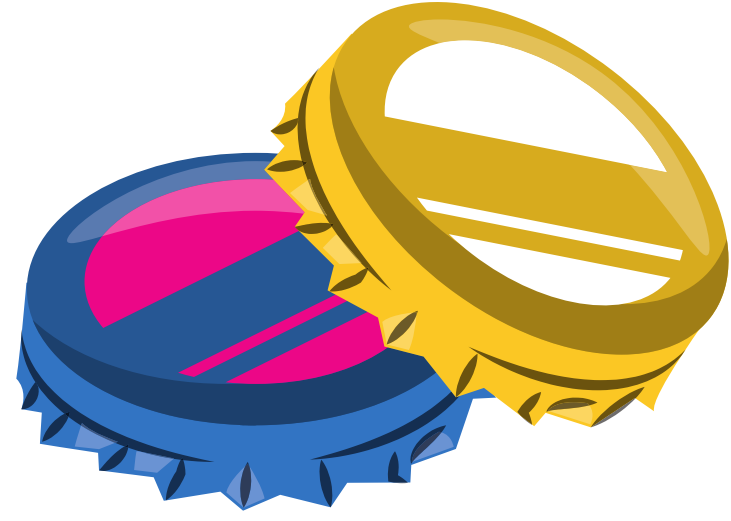
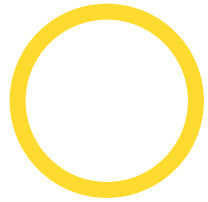
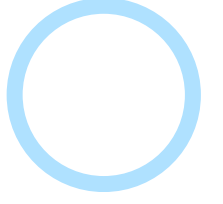
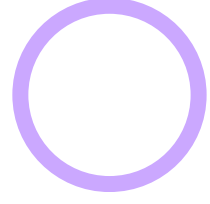
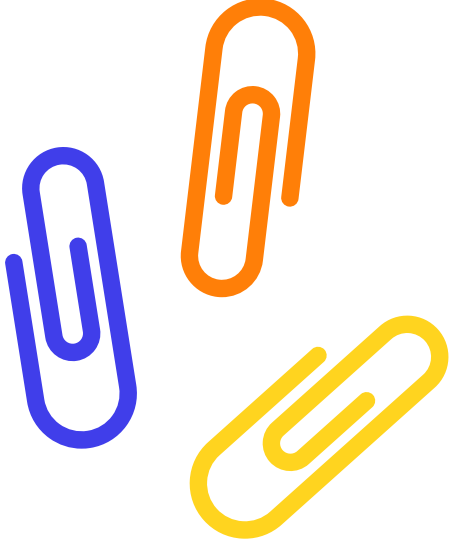
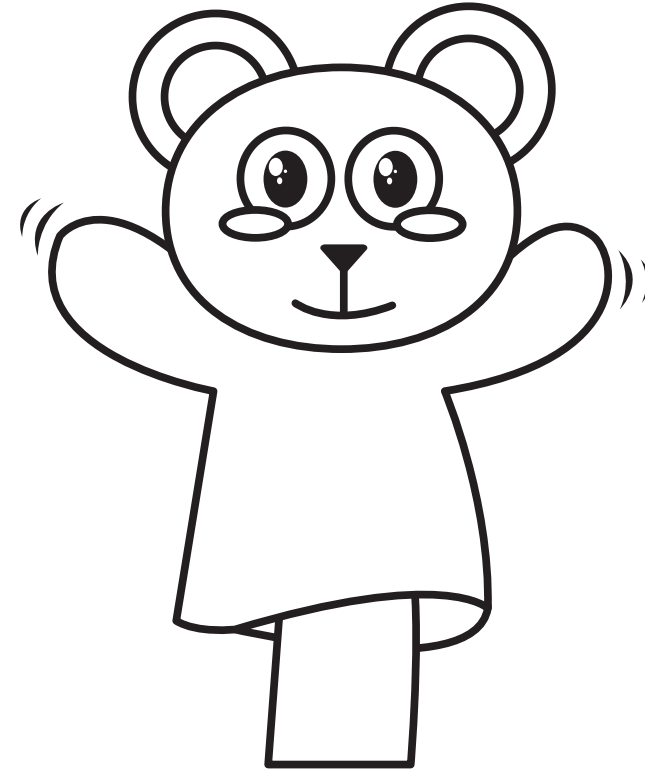
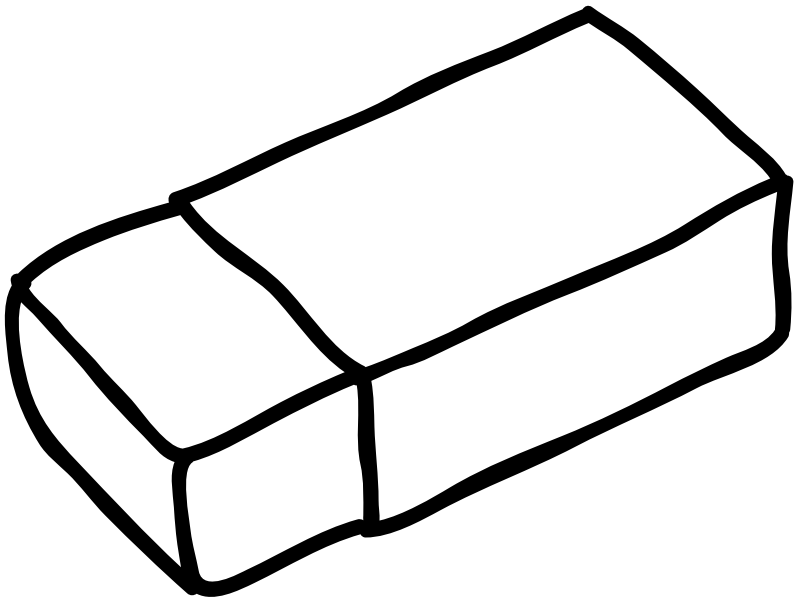
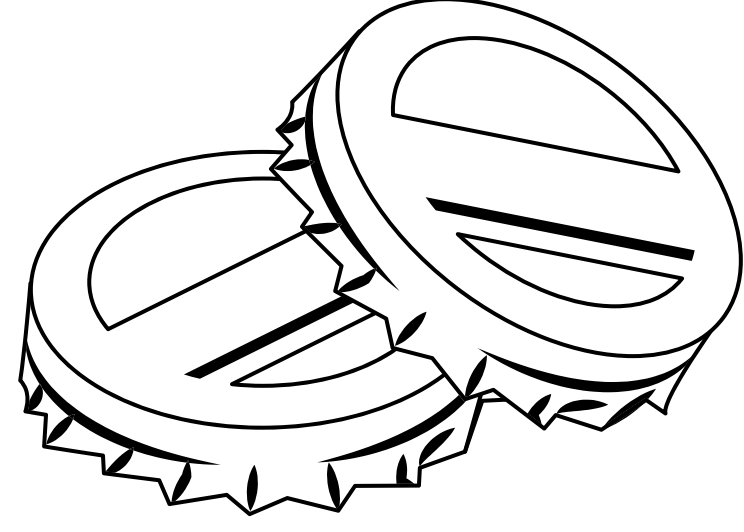
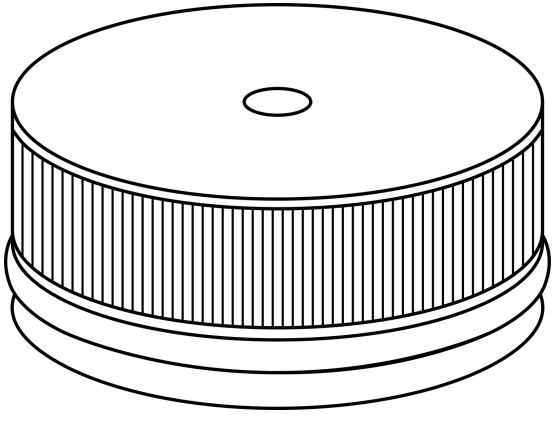
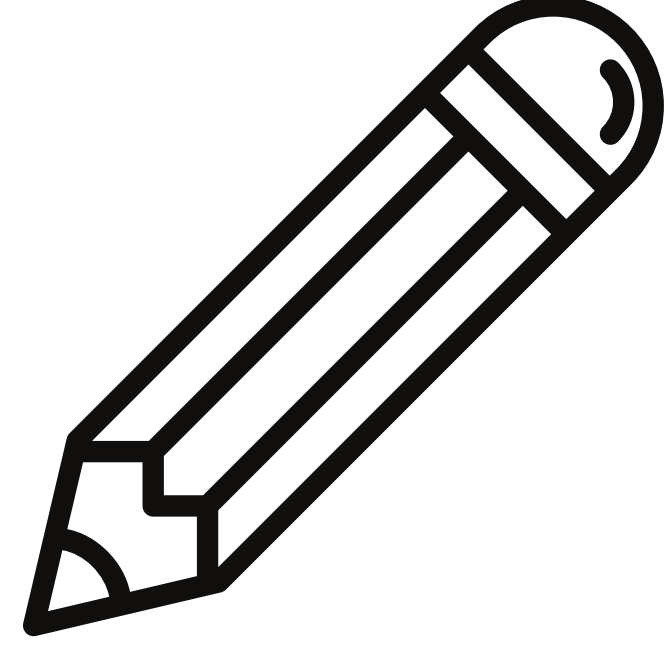
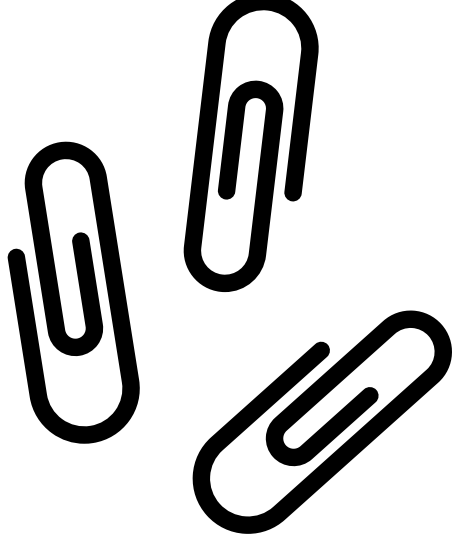

Yönerge: Miktatsın çektiklerini işaretler misin?